

FEATURES

- Operation from 1800 MHz to 2700 MHz
- Gain of 24.3 dB at 2140 MHz
- OIP3 of 45.5 dBm at 2140 MHz
- P1dB of 30.8 dBm at 2140 MHz
- Noise figure of 4.7 dB at 2140 MHz
- Power supply: 5 V
- Power supply current: 362 mA typical
- Internal active biasing
- Fast power-up/power-down function
- Compact 4 mm × 4 mm, 16-lead LFCSP
- ESD rating of ±1 kV (Class 1C)
- Pin-compatible with the [ADL5605](#) (700 MHz to 1000 MHz)

APPLICATIONS

- Wireless infrastructure
- Automated test equipment
- ISM/AMR applications

GENERAL DESCRIPTION

The [ADL5606](#) is a broadband, two-stage, 1 W RF driver amplifier that operates over a frequency range of 1800 MHz to 2700 MHz. The device can be used in a variety of wired and wireless applications, including ISM, MC-GSM, W-CDMA, TD-SCDMA, and LTE.

The [ADL5606](#) operates on a 5 V supply voltage and a supply current of 362 mA. The driver also incorporates a fast power-up/power-down function for TDD applications, applications that require a power saving mode, and applications that intermittently transmit data.

The [ADL5606](#) is fabricated on a GaAs HBT process and is packaged in a compact 4 mm × 4 mm, 16-lead LFCSP that uses an exposed paddle for excellent thermal impedance. The [ADL5606](#) operates from -40°C to +85°C. A fully populated evaluation board tuned to 2140 MHz is also available.

FUNCTIONAL BLOCK DIAGRAM

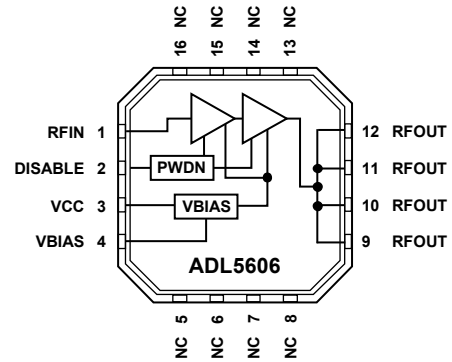

Figure 1.

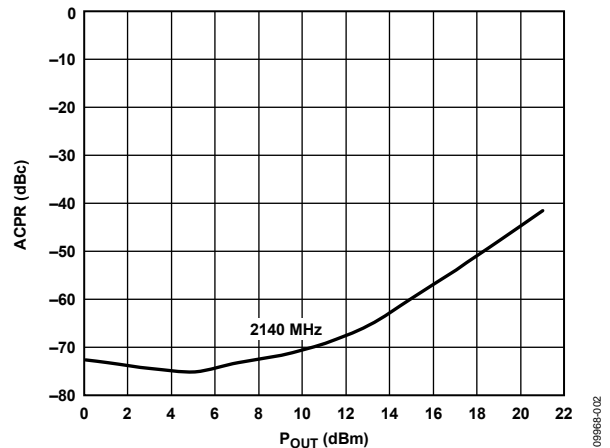

Figure 2. ACPR vs. Output Power, 3GPP, TM1-64, at 2140 MHz

Rev. 0

Information furnished by Analog Devices is believed to be accurate and reliable. However, no responsibility is assumed by Analog Devices for its use, nor for any infringements of patents or other rights of third parties that may result from its use. Specifications subject to change without notice. No license is granted by implication or otherwise under any patent or patent rights of Analog Devices. Trademarks and registered trademarks are the property of their respective owners.

TABLE OF CONTENTS

Features	1	2140 MHz Frequency Tuning Band.....	9
Applications.....	1	2630 MHz Frequency Tuning Band.....	10
General Description	1	General.....	11
Functional Block Diagram	1	Applications Information	13
Revision History	2	Basic Layout Connections.....	13
Specifications.....	3	ADL5606 Matching.....	14
Typical Scattering Parameters.....	4	ACPR and EVM	15
Absolute Maximum Ratings.....	6	Thermal Considerations.....	15
Thermal Resistance	6	Soldering Information and Recommended PCB Land	
ESD Caution.....	6	Pattern.....	15
Pin Configuration and Function Descriptions.....	7	Evaluation Board	16
Typical Performance Characteristics	8	Outline Dimensions	18
1960 MHz Frequency Tuning Band.....	8	Ordering Guide	18

REVISION HISTORY

7/11—Revision 0: Initial Version

SPECIFICATIONS

VCC1 = 5 V and T_A = 25°C, unless otherwise noted.¹

Table 1.

Parameter	Test Conditions/Comments	Min	Typ	Max	Unit
OVERALL FUNCTION					
Frequency Range		1800		2700	MHz
FREQUENCY = 1960 MHz ± 30 MHz					
Gain			24.7		dB
vs. Frequency	±30 MHz		±0.5		dB
vs. Temperature	-40°C ≤ T _A ≤ +85°C		±0.9		dB
vs. Supply	4.75 V to 5.25 V		±0.05		dB
Output 1 dB Compression Point (P1dB)			30.2		dBm
vs. Frequency	±30 MHz		+0.2/-0.6		dB
vs. Temperature	-40°C ≤ T _A ≤ +85°C		±0.5		dB
vs. Supply	4.75 V to 5.25 V		±0.5		dB
Adjacent Channel Power Ratio (ACPR)	P _{OUT} = 18 dBm, one-carrier W-CDMA, 64 DPCH		52		dBc
Output Third-Order Intercept (OIP3)	Δf = 1 MHz, P _{OUT} = 14 dBm per tone		45.6		dBm
vs. Frequency	±30 MHz		+0.8/-0.2		dB
vs. Temperature	-40°C ≤ T _A ≤ +85°C		+0.0/-2.2		dB
vs. Supply	4.75 V to 5.25 V		±0.5		dB
Noise Figure			5.1		dB
FREQUENCY = 2140 MHz ± 30 MHz					
Gain			24.3		dB
vs. Frequency	±30 MHz		+0.4/-0.1		dB
vs. Temperature	-40°C ≤ T _A ≤ +85°C		±0.9		dB
vs. Supply	4.75 V to 5.25 V		±0.06		dB
Output 1 dB Compression Point (P1dB)			30.8		dBm
vs. Frequency	±30 MHz		±0.5		dB
vs. Temperature	-40°C ≤ T _A ≤ +85°C		±0.8		dB
vs. Supply	4.75 V to 5.25 V		±0.4		dB
Adjacent Channel Power Ratio (ACPR)	P _{OUT} = 18 dBm, one-carrier W-CDMA, 64 DPCH		51		dBc
Output Third-Order Intercept (OIP3)	Δf = 1 MHz, P _{OUT} = 14 dBm per tone		45.5		dBm
vs. Frequency	±30 MHz		+2.3/-0.8		dB
vs. Temperature	-40°C ≤ T _A ≤ +85°C		+0.0/-2.5		dB
vs. Supply	4.75 V to 5.25 V		+0.6/-0.3		dB
Noise Figure			4.7		dB
FREQUENCY = 2630 MHz ± 60 MHz					
Gain			20.6		dB
vs. Frequency	±60 MHz		+0.7/-1.8		dB
vs. Temperature	-40°C ≤ T _A ≤ +85°C		±1.0		dB
vs. Supply	4.75 V to 5.25 V		±0.09		dB
Output 1 dB Compression Point (P1dB)			28.9		dBm
vs. Frequency	±60 MHz		+0.5/-1.7		dB
vs. Temperature	-40°C ≤ T _A ≤ +85°C		+1.2/-2.0		dB
vs. Supply	4.75 V to 5.25 V		±0.2		dB
Output Third-Order Intercept (OIP3)	Δf = 1 MHz, P _{OUT} = 14 dBm per tone		43.2		dBm
vs. Frequency	±60 MHz		±3.0		dB
vs. Temperature	-40°C ≤ T _A ≤ +85°C		+0.3/-4.0		dB
vs. Supply	4.75 V to 5.25 V		±1.9		dB
Noise Figure			5.1		dB

ADL5606

Parameter	Test Conditions/Comments	Min	Typ	Max	Unit
POWER-DOWN INTERFACE	DISABLE pin				
Logic Level to Enable	V _{DISABLE} decreasing		0	1.1	V
Logic Level to Disable	V _{DISABLE} increasing	1.4	5		V
DISABLE Pin Current	V _{DISABLE} = 5 V		1.4		mA
VCC1 Pin Current ¹	V _{DISABLE} = 5 V		4.2		mA
Enable Time	10% of control pulse to 90% of RFOUT		75		ns
Disable Time	10% of control pulse to 90% of RFOUT		20		ns
POWER INTERFACE	RFOUT pin				
Supply Voltage		4.75	5	5.25	V
Supply Current			362	390	mA
vs. Temperature	-40°C ≤ T _A ≤ +85°C		+0/-25		mA

¹ VCC1 is the supply to the DUT through the RFOUT pins.

TYPICAL SCATTERING PARAMETERS

VCC1 = 5 V and T_A = 25°C; the effects of the test fixture have been de-embedded up to the pins of the device.¹

Table 2.

Frequency (MHz)	S11		S21		S12		S22	
	Magnitude (dB)	Angle (°)	Magnitude (dB)	Angle (°)	Magnitude (dB)	Angle (°)	Magnitude (dB)	Angle (°)
1000	-5.94	1.63	25.77	42.78	-64.90	91.56	-1.68	179.86
1050	-7.09	-24.39	25.28	25.40	-63.13	114.08	-1.63	179.29
1100	-7.74	-48.66	24.68	10.90	-58.63	108.53	-1.54	178.87
1150	-7.94	-69.86	23.97	-1.40	-58.57	98.35	-1.53	178.32
1200	-7.82	-87.28	23.32	-12.01	-59.58	114.37	-1.53	177.95
1250	-7.46	-100.72	22.71	-21.44	-55.02	106.02	-1.46	177.27
1300	-7.06	-111.67	22.14	-29.87	-52.50	102.74	-1.45	176.60
1350	-6.70	-120.51	21.64	-37.10	-54.05	91.45	-1.43	176.34
1400	-6.38	-126.95	21.16	-44.03	-53.01	111.40	-1.39	175.90
1450	-6.08	-133.47	20.75	-50.61	-51.79	83.98	-1.35	175.36
1500	-5.76	-138.12	20.33	-56.84	-53.89	111.28	-1.38	174.93
1550	-5.47	-142.70	19.98	-62.62	-53.41	117.99	-1.35	174.51
1600	-5.24	-146.61	19.67	-68.33	-53.37	76.10	-1.34	174.16
1650	-5.02	-150.10	19.36	-73.72	-51.35	87.47	-1.30	173.84
1700	-4.76	-153.11	19.07	-79.01	-50.65	92.39	-1.26	173.35
1750	-4.58	-155.89	18.79	-83.92	-50.70	83.18	-1.24	173.01
1800	-4.42	-158.41	18.52	-88.97	-51.02	92.52	-1.23	172.59
1850	-4.25	-160.75	18.28	-93.94	-50.59	93.13	-1.23	172.28
1900	-4.11	-162.84	18.01	-98.66	-50.81	82.49	-1.21	171.75
1950	-3.97	-164.79	17.78	-103.29	-50.52	90.57	-1.18	171.61
2000	-3.82	-166.56	17.56	-107.86	-52.43	75.32	-1.19	171.19
2050	-3.72	-168.58	17.34	-112.42	-49.77	80.61	-1.17	170.99
2100	-3.61	-170.35	17.13	-116.91	-50.35	81.31	-1.16	170.70
2150	-3.50	-172.01	16.90	-121.14	-49.72	83.35	-1.16	170.44
2200	-3.42	-173.71	16.68	-125.59	-50.21	87.74	-1.16	170.09
2250	-3.36	-175.63	16.47	-129.80	-47.59	82.95	-1.17	169.84
2300	-3.28	-177.44	16.27	-134.15	-47.62	88.25	-1.14	169.46
2350	-3.23	-179.05	16.02	-138.14	-48.93	79.29	-1.16	169.27
2400	-3.23	179.33	15.79	-142.35	-49.37	83.50	-1.18	169.01
2450	-3.19	177.86	15.58	-146.40	-48.09	75.23	-1.18	168.72
2500	-3.15	176.27	15.37	-150.40	-47.72	78.72	-1.16	168.34
2550	-3.17	174.60	15.15	-154.46	-47.40	76.72	-1.18	168.15

Frequency (MHz)	S11		S21		S12		S22	
	Magnitude (dB)	Angle (°)	Magnitude (dB)	Angle (°)	Magnitude (dB)	Angle (°)	Magnitude (dB)	Angle (°)
2600	-3.14	172.86	14.92	-158.40	-46.51	77.12	-1.20	167.77
2650	-3.14	171.24	14.70	-162.27	-47.66	73.90	-1.20	167.47
2700	-3.12	169.74	14.48	-166.06	-47.77	71.80	-1.22	167.16
2750	-3.14	167.93	14.24	-169.97	-45.35	73.70	-1.22	166.68
2800	-3.16	166.21	13.98	-173.76	-45.43	76.05	-1.24	166.34
2850	-3.15	164.65	13.78	-177.32	-46.35	71.78	-1.25	166.25
2900	-3.15	162.67	13.53	178.93	-46.92	73.31	-1.26	165.90
2950	-3.15	160.86	13.27	175.30	-45.88	70.64	-1.30	165.58
3000	-3.14	159.03	13.04	171.76	-45.94	66.79	-1.29	165.35
3050	-3.13	157.22	12.79	168.32	-45.60	73.37	-1.33	165.06
3100	-3.08	155.39	12.57	165.01	-44.06	61.32	-1.35	164.76
3150	-3.01	152.90	12.32	161.32	-45.54	58.34	-1.36	164.32
3200	-3.08	150.72	12.04	157.39	-46.51	60.72	-1.36	163.65
3250	-3.06	149.25	11.78	153.80	-43.87	61.02	-1.35	163.38
3300	-3.05	147.28	11.53	150.59	-44.31	68.64	-1.36	162.94
3350	-3.03	145.53	11.20	147.57	-44.17	62.82	-1.39	162.61
3400	-2.94	143.76	10.95	144.00	-43.67	64.76	-1.39	162.08
3450	-2.95	141.94	10.65	141.12	-44.65	72.58	-1.39	161.92
3500	-2.85	140.04	10.39	137.78	-44.52	53.43	-1.38	161.39
3550	-2.83	138.58	10.10	134.68	-44.22	63.44	-1.35	161.11
3600	-2.79	136.47	9.83	131.38	-43.79	46.56	-1.36	160.74
3650	-2.74	134.67	9.55	128.32	-42.04	50.76	-1.31	160.48
3700	-2.78	132.80	9.25	125.07	-43.97	57.92	-1.33	160.24
3750	-2.80	130.85	8.94	121.74	-42.96	49.24	-1.30	159.79
3800	-2.87	128.85	8.63	119.06	-43.01	51.05	-1.30	159.68
3850	-3.03	126.98	8.30	115.71	-41.84	45.82	-1.24	159.28
3900	-3.24	125.26	7.90	113.11	-41.50	36.66	-1.26	159.17
3950	-3.63	123.34	7.59	110.08	-42.15	39.82	-1.20	159.15
4000	-4.24	122.71	7.15	108.11	-41.81	41.17	-1.21	159.19

¹ VCC1 is the supply to the DUT through the RFOUT pins.

ABSOLUTE MAXIMUM RATINGS

Table 3.

Parameter	Rating
Supply Voltage, VCC1 ¹	6.5 V
Input Power (50 Ω Impedance)	18 dBm
Internal Power Dissipation (Paddle Soldered)	3.5 W
Maximum Junction Temperature	150°C
Lead Temperature (Soldering 60 sec)	240°C
Operating Temperature Range	-40°C to +85°C
Storage Temperature Range	-65°C to +150°C

¹ VCC1 is the supply to the DUT through the RFOUT pins.

Stresses above those listed under Absolute Maximum Ratings may cause permanent damage to the device. This is a stress rating only; functional operation of the device at these or any other conditions above those indicated in the operational section of this specification is not implied. Exposure to absolute maximum rating conditions for extended periods may affect device reliability.

THERMAL RESISTANCE

Table 4 lists the junction-to-air thermal resistance (θ_{JA}) and the junction-to-paddle thermal resistance (θ_{JC}) for the [ADL5606](#). For more information, see the Thermal Considerations section.

Table 4. Thermal Resistance

Package Type	θ_{JA}	θ_{JC}	Unit
16-Lead LFCSP (CP-16-10)	52.9	12.9	°C/W

ESD CAUTION



ESD (electrostatic discharge) sensitive device. Charged devices and circuit boards can discharge without detection. Although this product features patented or proprietary protection circuitry, damage may occur on devices subjected to high energy ESD. Therefore, proper ESD precautions should be taken to avoid performance degradation or loss of functionality.

PIN CONFIGURATION AND FUNCTION DESCRIPTIONS

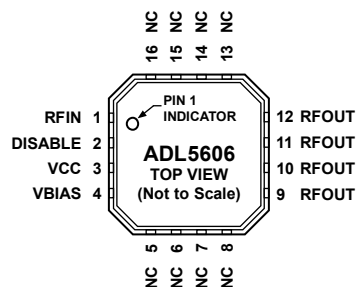

- NOTES**
1. THE EXPOSED PADDLE SHOULD BE SOLDERED TO A LOW IMPEDANCE ELECTRICAL AND THERMAL GROUND PLANE.
 2. NC = NO CONNECT. DO NOT CONNECT TO THIS PIN.

09986-003

Figure 3. Pin Configuration

Table 5. Pin Function Descriptions

Pin No.	Mnemonic	Description
1	RFIN	RF Input. Requires a dc blocking capacitor.
2	DISABLE	Connect this pin to 5 V to disable the part. In the disabled state, the part draws approximately 4 mA of current from the power supply and 1.4 mA from the DISABLE pin.
3	VCC	Under normal operation, this pin is connected to the power supply and draws a combined 362 mA of current. When this pin is grounded along with the VBIAS pin, the device is disabled and draws approximately 1.4 mA from the DISABLE pin.
4	VBIAS	Applying 5 V to this pin enables the bias circuit. When this pin is grounded, the device is disabled.
5, 6, 7, 8, 13, 14, 15, 16	NC	No Connect. Do not connect to this pin.
9, 10, 11, 12	RFOUT	RF Output. DC bias is provided to this pin through an inductor that is connected to the 5 V power supply. The RF path requires a dc blocking capacitor.
	EP	The exposed paddle should be soldered to a low impedance electrical and thermal ground plane.

TYPICAL PERFORMANCE CHARACTERISTICS

1960 MHZ FREQUENCY TUNING BAND

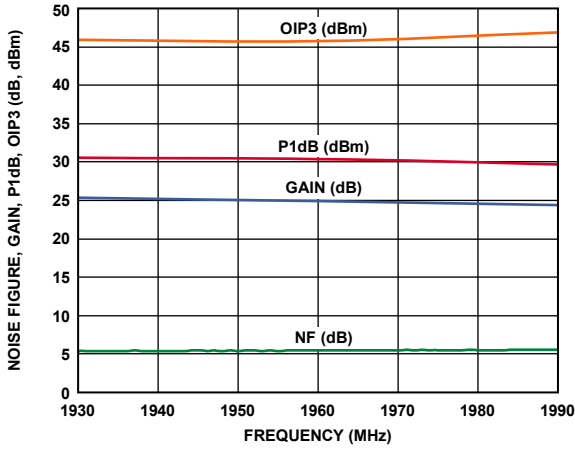

Figure 4. Noise Figure, Gain, P1dB, and OIP3 vs. Frequency (OIP3 at $P_{OUT} = 14$ dBm per Tone)

09968-004

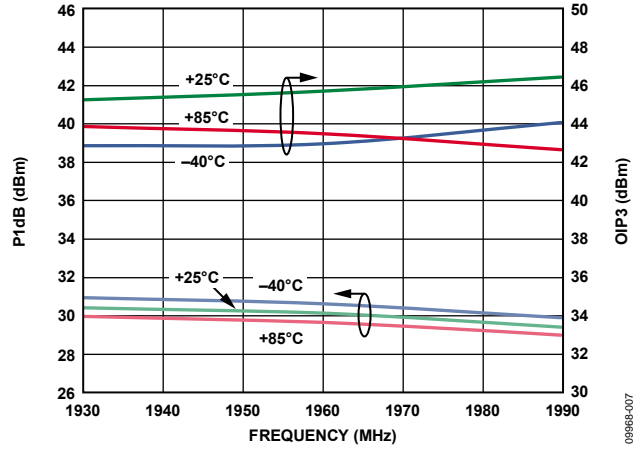

Figure 7. P1dB and OIP3 vs. Frequency and Temperature (OIP3 at $P_{OUT} = 14$ dBm per Tone)

09968-007

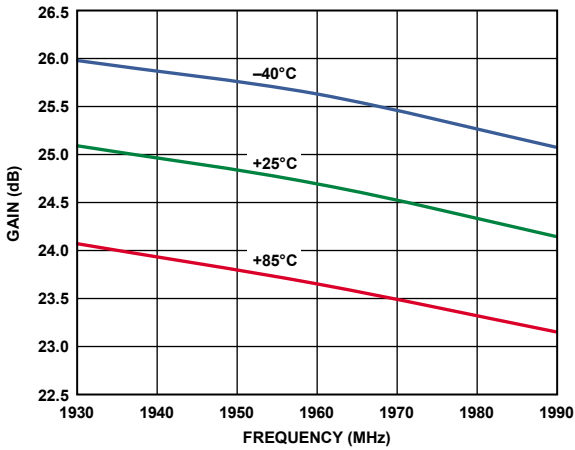

Figure 5. Gain vs. Frequency and Temperature

09968-005

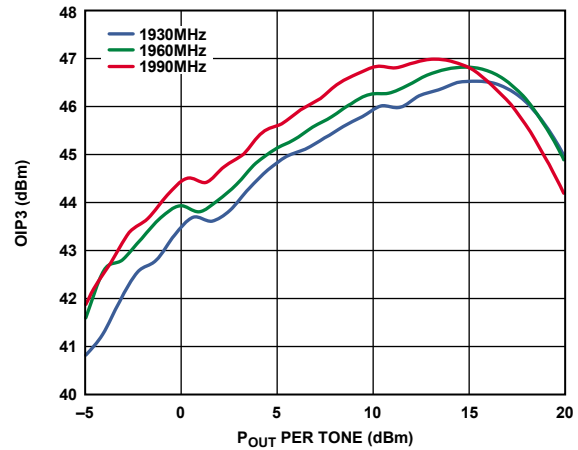

Figure 8. OIP3 vs. P_{OUT} and Frequency

09968-008

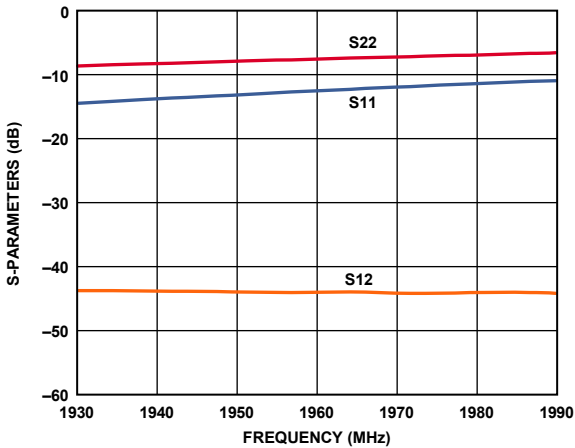

Figure 6. Input Return Loss (S11), Output Return Loss (S22), and Reverse Isolation (S12) vs. Frequency

09968-006

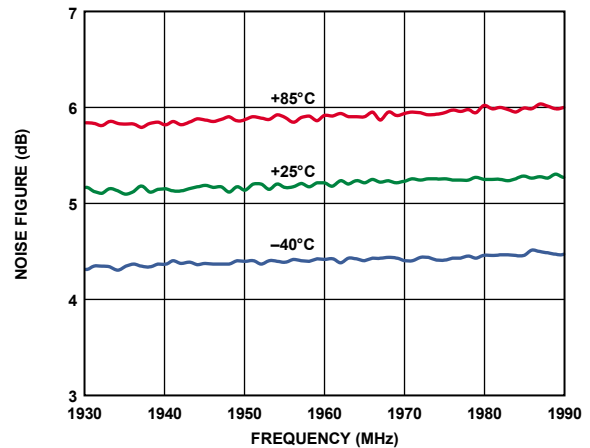

Figure 9. Noise Figure vs. Frequency and Temperature

09968-009

2140 MHZ FREQUENCY TUNING BAND

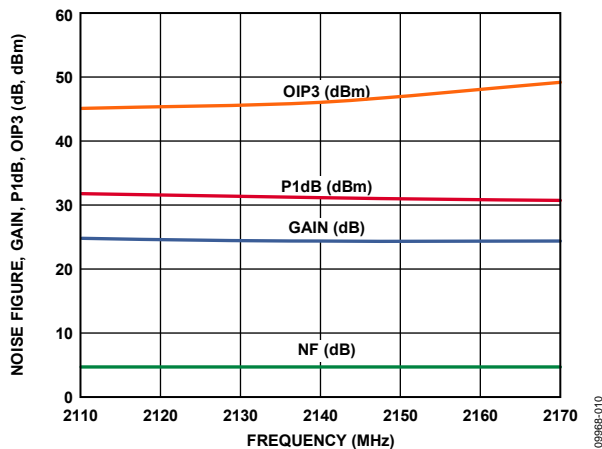

Figure 10. Noise Figure, Gain, P1dB, and OIP3 vs. Frequency (OIP3 at $P_{OUT} = 14$ dBm per Tone)

0996B-010

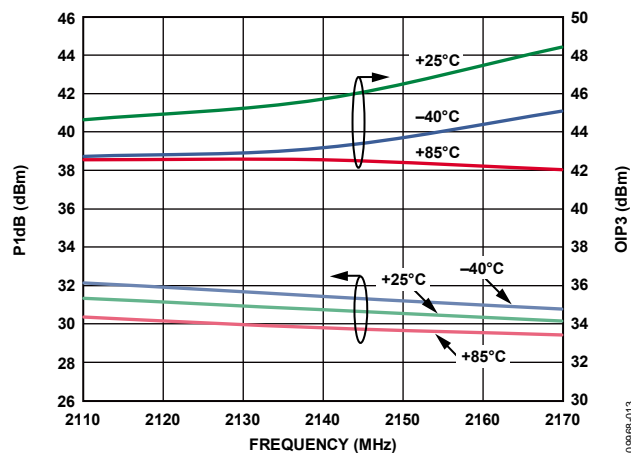

Figure 13. P1dB and OIP3 vs. Frequency and Temperature (OIP3 at $P_{OUT} = 14$ dBm per Tone)

0996B-013

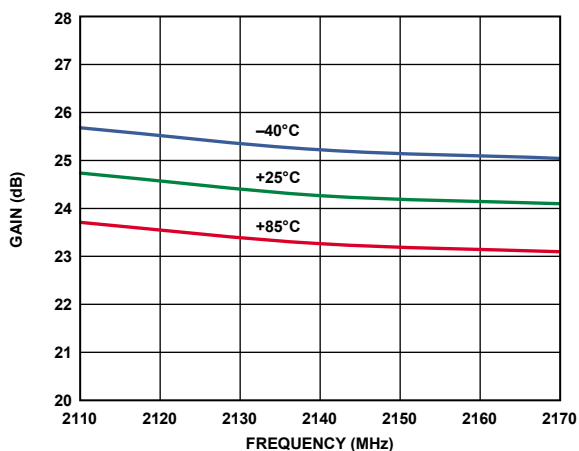

Figure 11. Gain vs. Frequency and Temperature

0996B-011

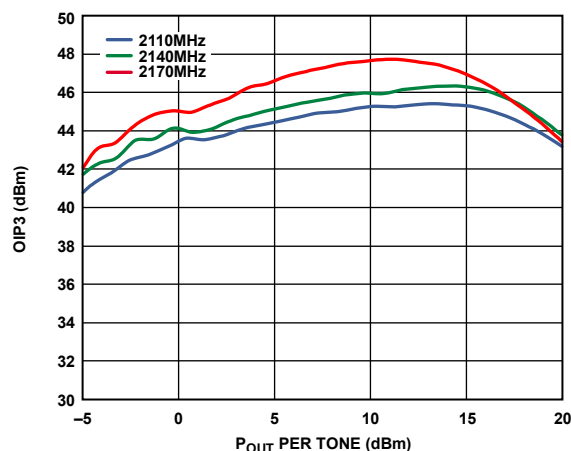

Figure 14. OIP3 vs. P_{OUT} and Frequency

0996B-014

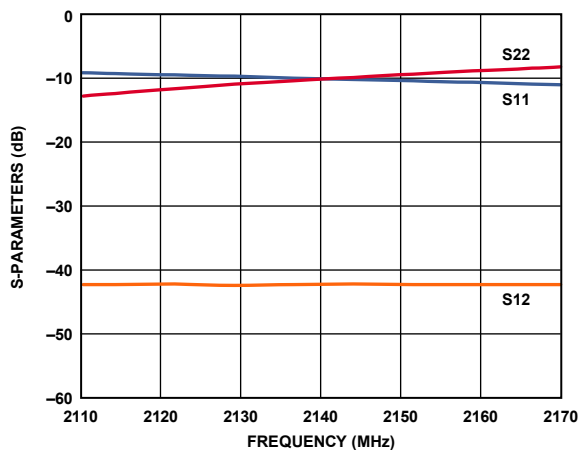

Figure 12. Input Return Loss (S11), Output Return Loss (S22), and Reverse Isolation (S12) vs. Frequency

0996B-012

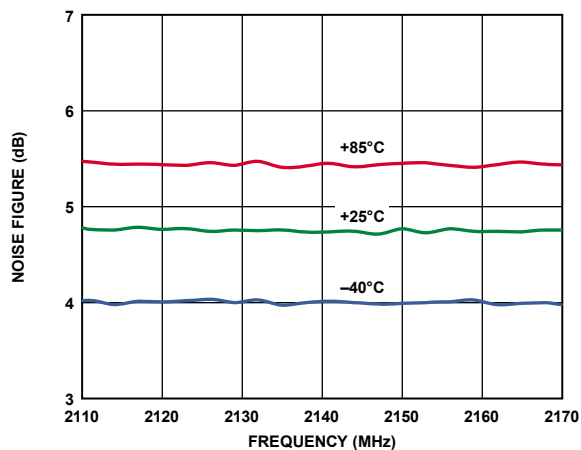

Figure 15. Noise Figure vs. Frequency and Temperature

0996B-015

2630 MHZ FREQUENCY TUNING BAND

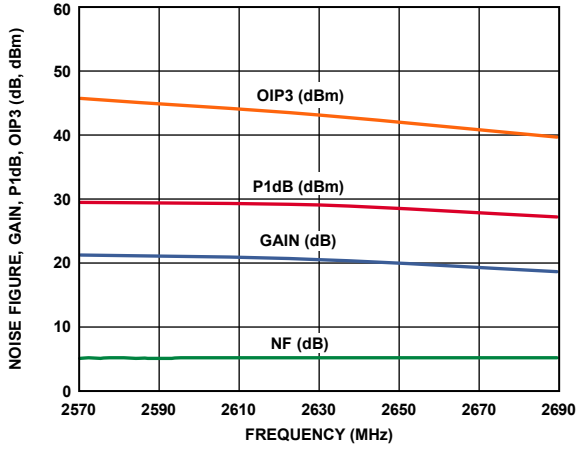

Figure 16. Noise Figure, Gain, P1dB, and OIP3 vs. Frequency (OIP3 at $P_{OUT} = 14$ dBm per Tone)

09968-016

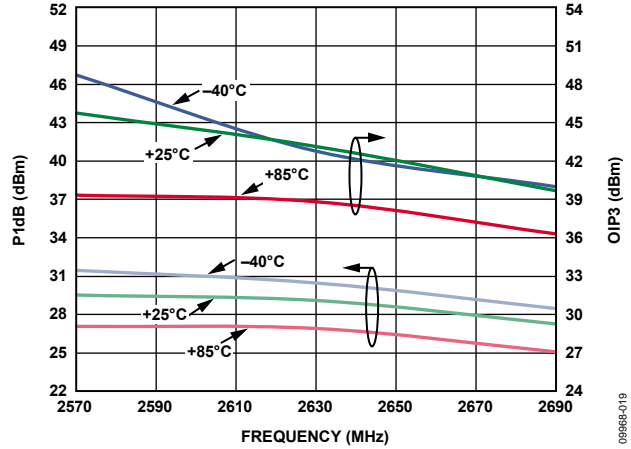

Figure 19. P1dB and OIP3 vs. Frequency and Temperature (OIP3 at $P_{OUT} = 14$ dBm per Tone)

09968-019

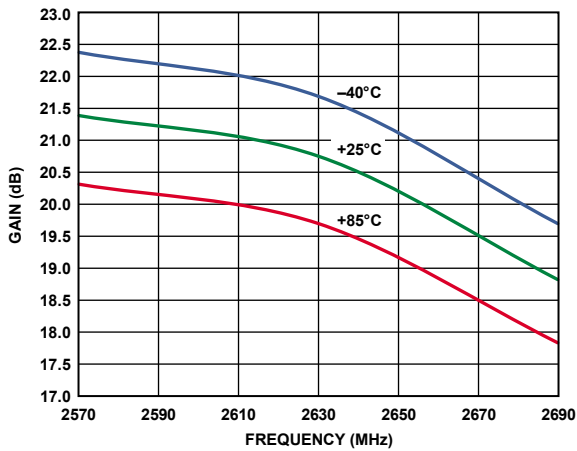

Figure 17. Gain vs. Frequency and Temperature

09968-017

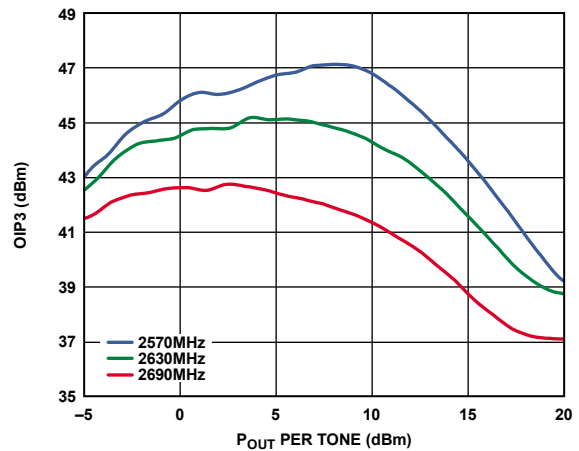

Figure 20. OIP3 vs. P_{OUT} and Frequency

09968-020

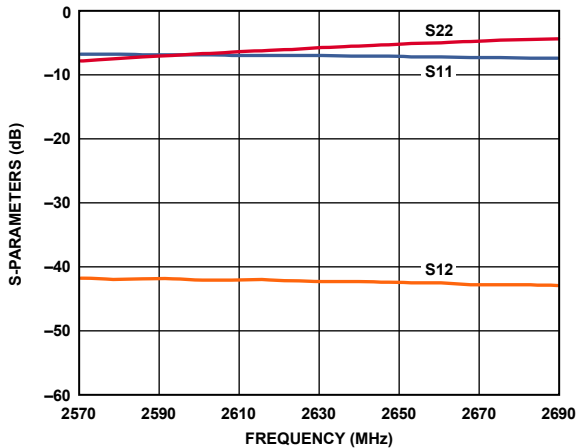

Figure 18. Input Return Loss (S11), Output Return Loss (S22), and Reverse Isolation (S12) vs. Frequency

09968-018

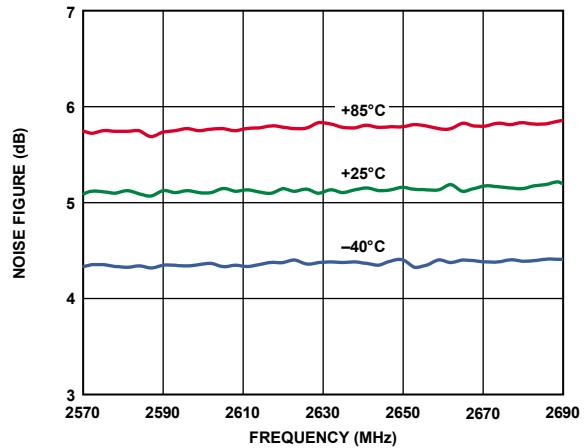

Figure 21. Noise Figure vs. Frequency and Temperature

09968-021

GENERAL

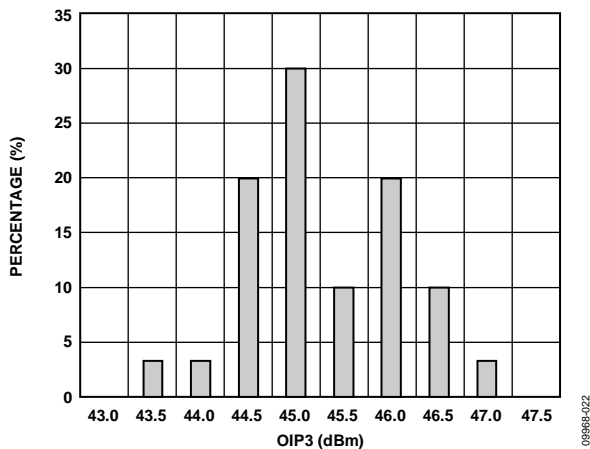

Figure 22. OIP3 Distribution at 2140 MHz, 14 dBm per Tone

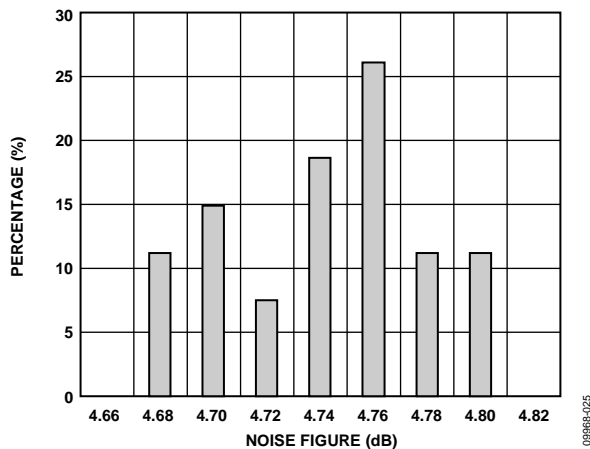

Figure 25. Noise Figure Distribution at 2140 MHz

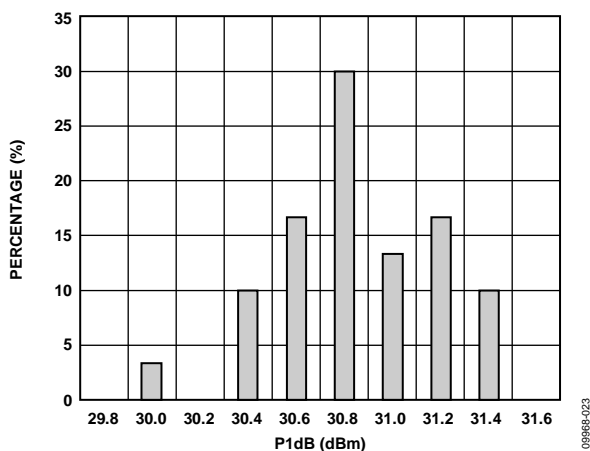

Figure 23. P1dB Distribution at 2140 MHz

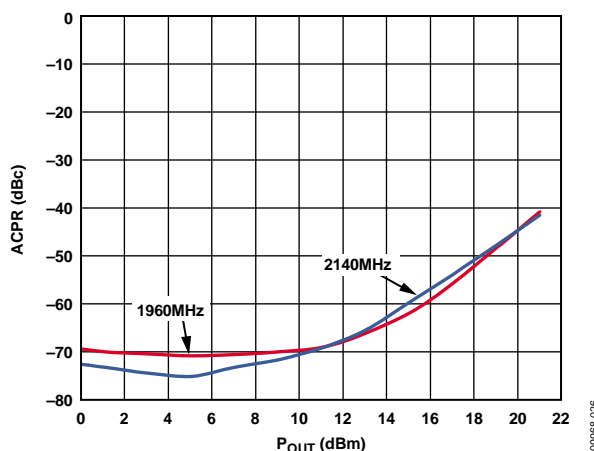

Figure 26. ACPR vs. P_{out} , 3GPP, TM1-64, at 1960 MHz and 2140 MHz

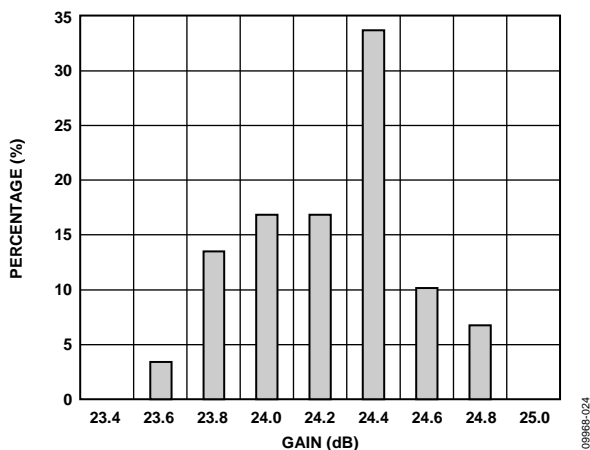

Figure 24. Gain Distribution at 2140 MHz

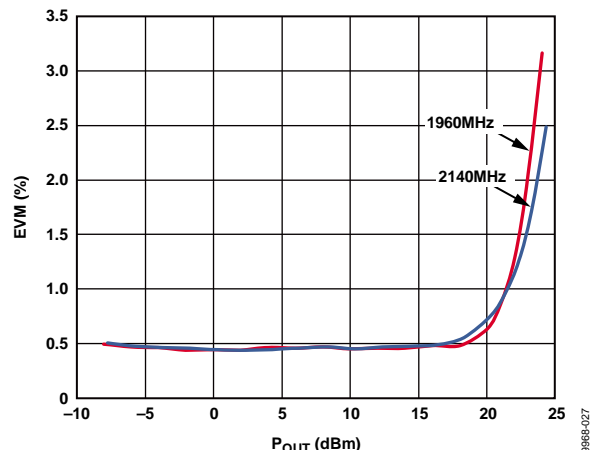

Figure 27. EVM vs. P_{out} , 3GPP, TM1-64, at 1960 MHz and 2140 MHz

ADL5606

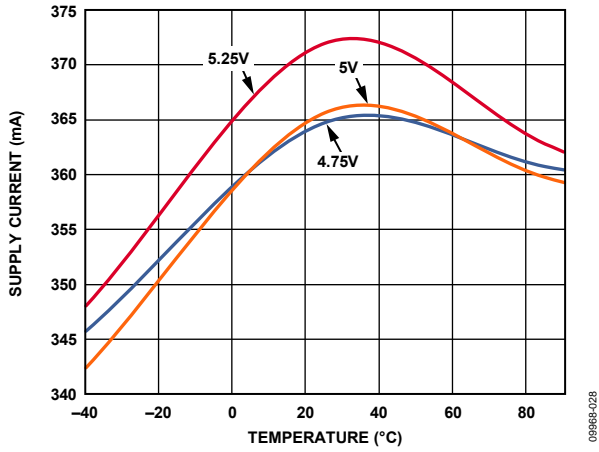

Figure 28. Supply Current vs. Temperature and Supply Voltage at 2140 MHz

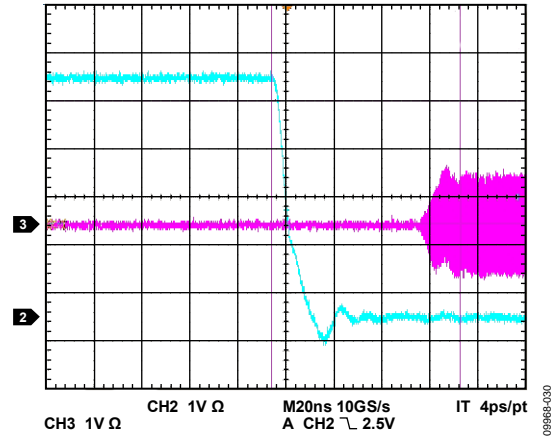

Figure 30. Turn-On Time, 10% of Control Pulse to 90% of RFOUT

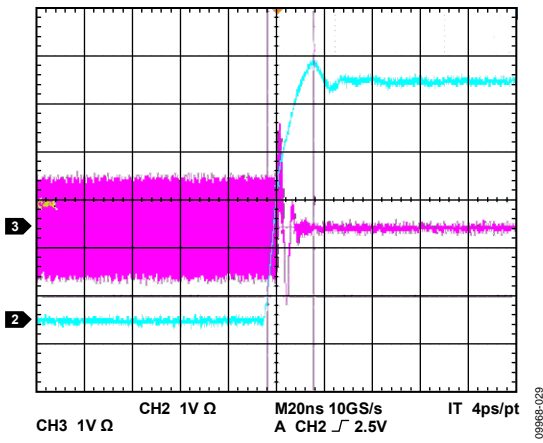

Figure 29. Turn-Off Time, 10% of Control Pulse to 90% of RFOUT

APPLICATIONS INFORMATION

BASIC LAYOUT CONNECTIONS

The basic connections for operating the ADL5606 are shown in Figure 31. The RF matching components correspond to the 2140 MHz frequency tuning band.

Power Supply

The voltage supply for the ADL5606, which ranges from 4.75 V to 5.25 V, should be connected to the VCC1 test pin. The dc bias to the output stage is supplied through L1 and is connected to the RFOUT pin. Three decoupling capacitors (C7, C8, and C9) are used to prevent RF signals from propagating on the dc lines. The VBIAS and VCC pins can be directly connected to the main supply voltage. Additional decoupling capacitors (C5, C6, and C11) are required on the VCC pin.

RF Input Interface

Pin 1 is the RF input pin for the ADL5606. The RF input is easily matched with one capacitor, in a series or shunt configuration, and a microstrip line used as an inductor. For the 1960 MHz and 2140 MHz frequency tuning bands, a shunt capacitor is used to match the input to 50 Ω ; for the 2630 MHz frequency tuning band, a series capacitor is used.

For complete information about component values and spacing for the different frequency tuning bands, see the ADL5606 Matching section.

RF Output Interface

Pin 9 to Pin 12 are the RF output pins. The RF output requires only one shunt capacitor and a microstrip line used as an inductor to match to 50 Ω . For complete information about component values and spacing for the different frequency tuning bands, see the ADL5606 Matching section.

Power-Down

The ADL5606 can be disabled by connecting the DISABLE pin to 5 V. When disabled, the ADL5606 draws approximately 4 mA of current from the power supply and 1.4 mA from the DISABLE pin. Decoupling Capacitor C3 is recommended to prevent the propagation of RF signals. To completely shut down the device, connect the VCC pin, the VBIAS pin, and the VCC1 test pin to ground. In this state, the part draws approximately 1.4 mA from the DISABLE pin.

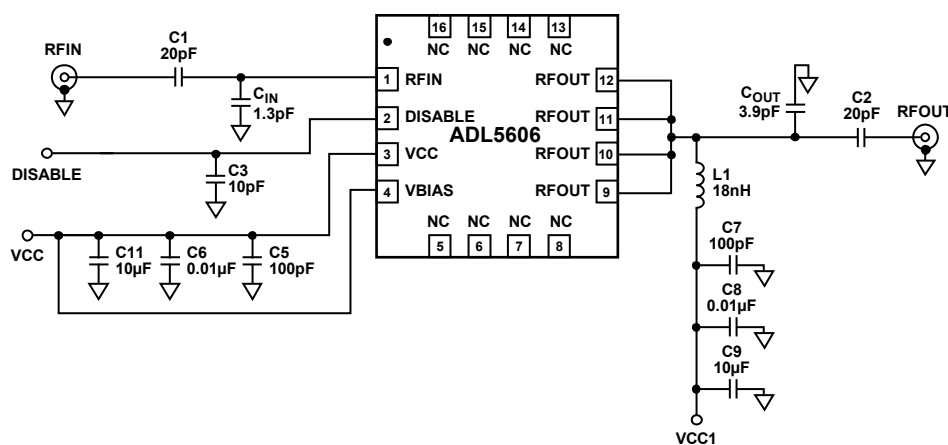

Figure 31. Basic Connections

09989-031

ADL5606

ADL5606 MATCHING

The RF input and output of the [ADL5606](#) can be easily matched to $50\ \Omega$ with at most one external component and the microstrip line used as an inductor. Table 6 lists the required matching component values. Capacitors C_{IN} and C_{OUT} are Murata GRM155 series (0402 size).

For all frequency tuning bands, the placement of C_{IN} and C_{OUT} is critical. Table 7 lists the recommended component spacing for the various frequency tuning bands. The component spacing is referenced from the center of the component to the edge of the package.

Figure 32 to Figure 34 show the matching networks.

Table 6. Recommended Components for Basic Connections

Frequency (MHz)	C_{IN} (pF)	C_{OUT} (pF)
1930 to 1990	2.0	3.6
2110 to 2170	1.3	3.9
2570 to 2690	2.0	3.3

Table 7. Matching Component Spacing

Frequency (MHz)	λ_1 (mils)	λ_2 (mils)
1930 to 1990	394	197
2110 to 2170	268	138
2570 to 2690	382	83

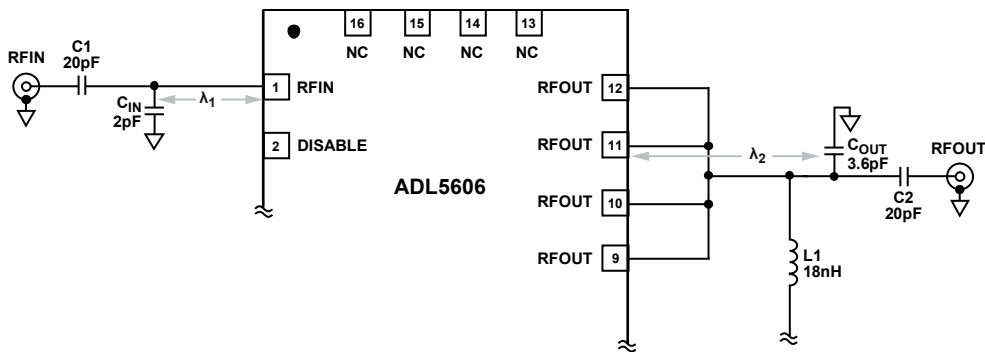

Figure 32. [ADL5606](#) Match Parameters, 1960 MHz Frequency Tuning Band

0996B-032

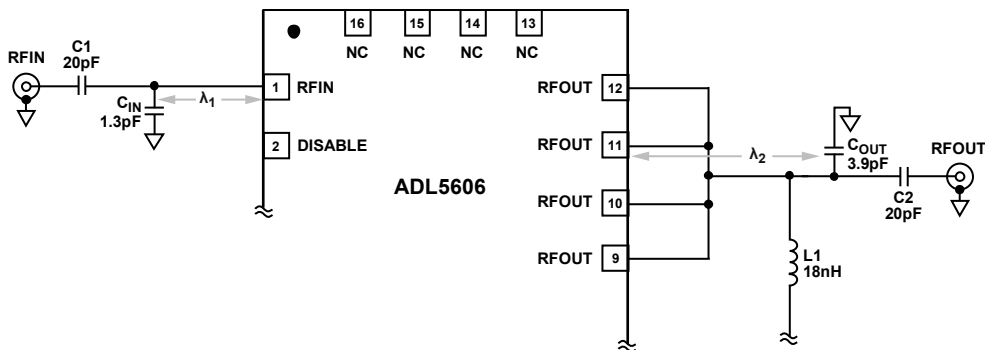

Figure 33. [ADL5606](#) Match Parameters, 2140 MHz Frequency Tuning Band

0996B-033

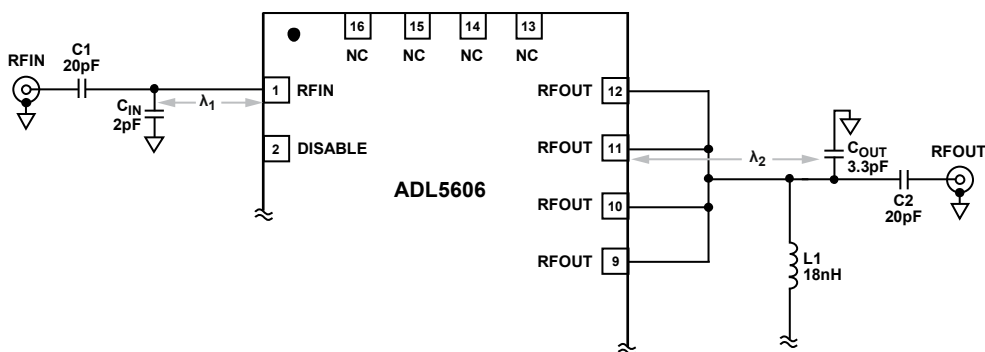

Figure 34. [ADL5606](#) Match Parameters, 2630 MHz Frequency Tuning Band

0996B-034

ACPR AND EVM

All adjacent channel power ratio (ACPR) and error vector magnitude (EVM) measurements were made using a single W-CDMA carrier and Test Model 1-64.

The signal is generated by a very low ACPR source and is measured at the output by a high dynamic range spectrum analyzer. For ACPR measurements, the filter setting was chosen for low ACPR; for EVM measurements, the low EVM setting was selected. The spectrum analyzer incorporates an instrument noise correction function, and highly linear amplifiers were used to boost the power levels for ACPR measurements.

Figure 26 shows ACPR vs. P_{OUT} at 1960 MHz and 2140 MHz. For power levels up to 18 dBm, an ACPR of 50 dBc or better can be achieved at 1960 MHz and 2140 MHz.

Figure 27 shows EVM vs. P_{OUT} at 1960 MHz and 2140 MHz. The EVM measured is 0.5% for power levels up to 18 dBm at 1960 MHz and 2140 MHz. The baseline composite EVM for the signal source was approximately 0.5%. When operated in the linear region, there is little or no contribution to EVM by the amplifier.

THERMAL CONSIDERATIONS

The ADL5606 is packaged in a thermally efficient 4 mm × 4 mm, 16-lead LFCSP. The thermal resistance from junction to air (θ_{JA}) is 52.9°C/W. The thermal resistance for the product was extracted assuming a standard 4-layer JEDEC board with 25 copper plated thermal vias. The thermal vias are filled with conductive copper paste (AE3030 with thermal conductivity of 7.8 W/mK and thermal expansion α_1 of $4 \times 10^{-5}/^{\circ}\text{C}$ and α_2 of $8.6 \times 10^{-5}/^{\circ}\text{C}$). The thermal resistance from junction to case (θ_{JC}) is 12.9°C/W, where the case is the exposed pad of the lead frame package.

For the best thermal performance, it is recommended that as many thermal vias as possible be added under the exposed pad of the LFCSP. The thermal resistance values assume a minimum of 25 thermal vias arranged in a 5 × 5 array with a via diameter of 8 mils, via pad of 16 mils, and a pitch of 20 mils. The vias are plated with copper, and the drill hole is filled with a conductive copper paste.

For optimal performance, it is recommended that the thermal vias be filled with a conductive paste of the equivalent thermal conductivity specified earlier in this section; alternatively, an external heat sink can be used to dissipate heat quickly without affecting the die junction temperature. It is also recommended that the ground pattern be extended above and below the device to improve thermal efficiency (see Figure 35).

SOLDERING INFORMATION AND RECOMMENDED PCB LAND PATTERN

Figure 35 shows the recommended land pattern for the ADL5606. To minimize thermal impedance, the exposed paddle on the 4 mm × 4 mm LFCSP is soldered to a ground plane along with Pin 5 to Pin 8 and Pin 13 to Pin 16. To improve thermal dissipation, 25 thermal vias are arranged in a 5 × 5 array under the exposed paddle. Areas above and below the paddle are tied with regular vias. If multiple ground layers exist, they should be tied together using vias. For more information about land pattern design and layout, see the AN-772 Application Note, *A Design and Manufacturing Guide for the Lead Frame Chip Scale Package (LFCSP)*.

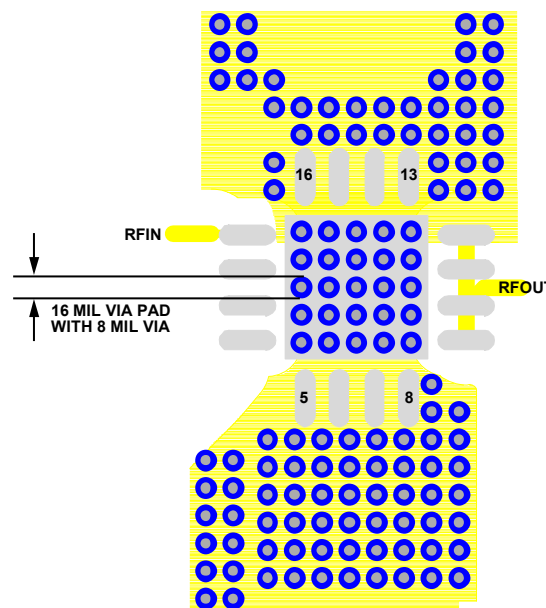

Figure 35. Recommended Land Pattern

009869-035

EVALUATION BOARD

The schematic of the [ADL5606](#) evaluation board is shown in Figure 36. The evaluation board uses 25 mils wide, 50 Ω traces and is made from IS410 material with a 20 mils gap to ground. The evaluation board is tuned for operation at 2140 MHz. The inputs and outputs should be ac-coupled with appropriately sized capacitors; therefore, for low frequency applications, the value of C1 and C2 may need to be increased. DC bias is provided to the output stage via an inductor (L1) connected to the RFOUT pin. A bias voltage of 5 V is recommended.

The evaluation board has a short, non-50 Ω line on its output to accommodate the four output pins and to allow for easier low inductance output matching. The pads for Pin 9 to Pin 12 are included on this microstrip line and are included in all matches. The evaluation board uses numbers as identifiers to aid in the placement of matching components at both the RF input and RF output of the device. Figure 37 and Figure 38 show images of the board layout.

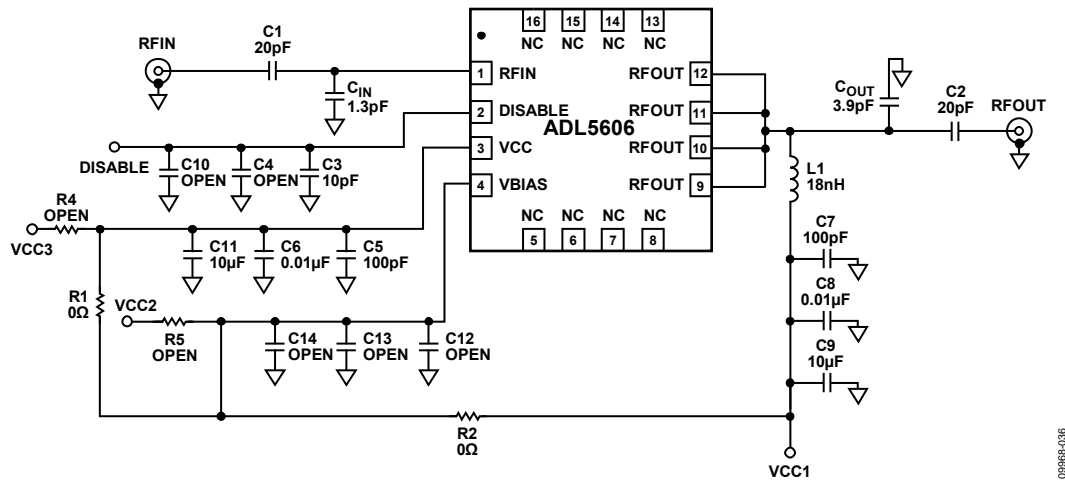
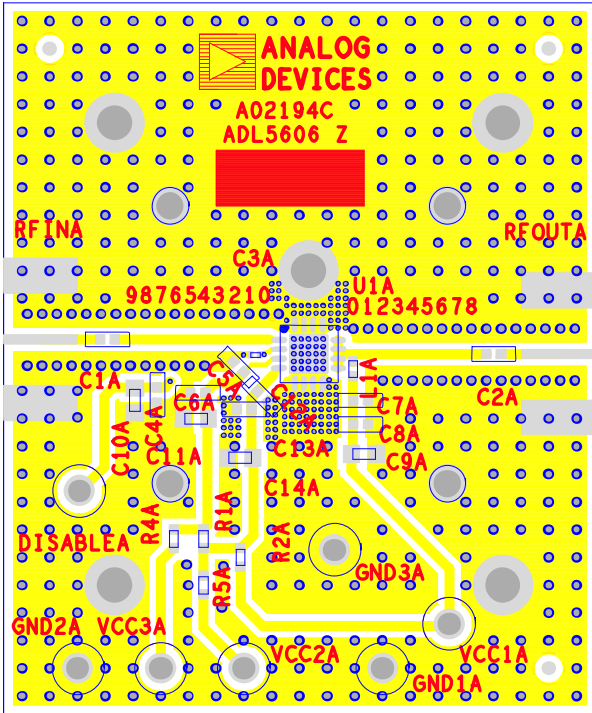

Figure 36. Evaluation Board, 2140 MHz Frequency Tuning Band

Table 8. Evaluation Board Configuration Options, 2140 MHz Frequency Tuning Band

Component	Function/Notes	Default Value
C1, C2	Input/output dc blocking capacitors.	C1, C2 = 20 pF
C3, C4, C5, C6, C7, C8, C9, C10, C11, C12, C13, C14	Power supply decoupling capacitors. Power supply decoupling capacitors are required to filter out the high frequency noise on the power supply. The smallest capacitor should be the closest to the ADL5606 . The main bias that goes through RFOUT is the most sensitive to noise because the bias is connected directly to the RF output. For the 1960 MHz and 2140 MHz frequency tuning bands, Capacitors C12, C13, and C14 are open; for the 2630 MHz frequency tuning band, it is recommended that the bypassing capacitors be added as follows: C12 = 100 pF, C13 = 0.01 μ F, and C14 = 10 μ F.	C3 = 10 pF C5, C7 = 100 pF C6, C8 = 0.01 μ F C9, C11 = 10 μ F C4, C10, C12, C13, C14 = open
C _{IN}	Input matching capacitor. To match the ADL5606 at the 2140 MHz frequency tuning band, Shunt Capacitor C _{IN} is required at a distance of 268 mils. If space is at a premium, an inductor can take the place of the microstrip line.	C _{IN} = 1.3 pF HQ
C _{OUT}	Output matching capacitor. C _{OUT} is set at a specific distance from the device so that the microstrip line can act as inductance for the matching network (see Table 7). If space is at a premium, an inductor can take the place of the microstrip line. A short length of low impedance line on the output is embedded in the match.	C _{OUT} = 3.9 pF HQ
L1	The main bias for the ADL5606 comes through L1 to the output stage. L1 should be high impedance for the frequency of operation while providing low resistance for the dc current. The evaluation board uses a Coilcraft® 0603HP-18NX_LU inductor; this 18 nH inductor provides some of the match at 2140 MHz.	L1 = 18 nH
R1, R2, R4, R5	To provide bias to all stages through just one supply, set R1 and R2 to 0 Ω , and leave R4 and R5 open. To provide separate bias to stages, set R1 and R2 to open and R4 and R5 to 0 Ω .	R1, R2 = 0 Ω R4, R5 = open
Exposed Paddle	The paddle should be connected to both thermal and electrical ground.	



09968-037

Figure 37. Evaluation Board Layout, Top

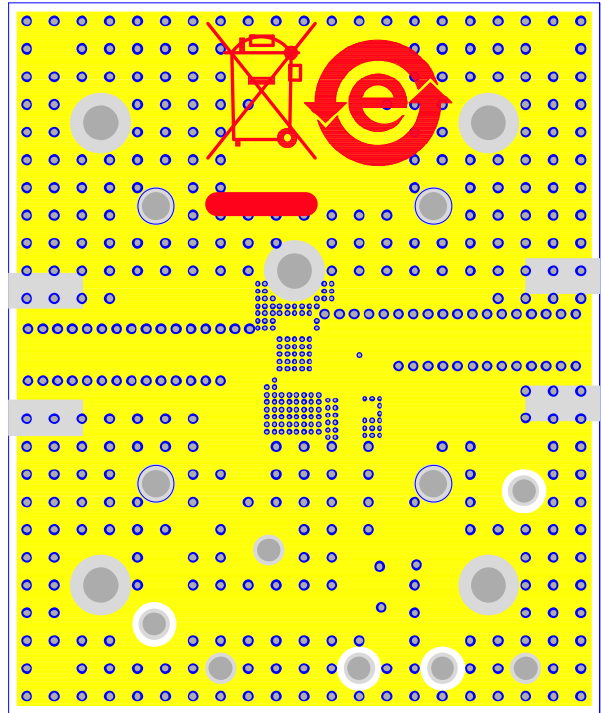

09968-038

Figure 38. Evaluation Board Layout, Bottom

OUTLINE DIMENSIONS

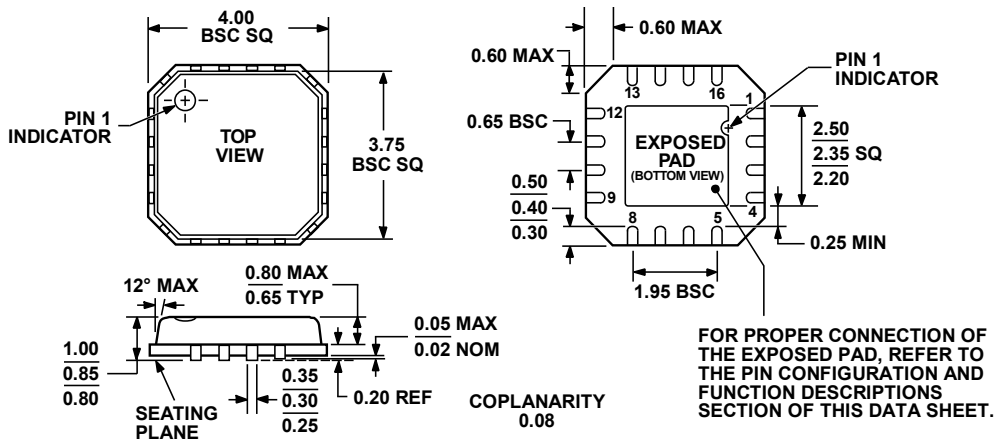

COMPLIANT TO JEDEC STANDARDS MO-220-VGGC

Figure 39. 16-Lead Lead Frame Chip Scale Package [LFCSP_VQ]
 4 mm × 4 mm Body, Very Thin Quad
 (CP-16-10)
 Dimensions shown in millimeters

082008-A

ORDERING GUIDE

Model ¹	Temperature Range	Package Description	Package Option
ADL5606ACPZ-R7	-40°C to +85°C	16-Lead Lead Frame Chip Scale Package [LFCSP_VQ]	CP-16-10
ADL5606-EVALZ		Evaluation Board	

¹ Z = RoHS Compliant Part.

NOTES

ADL5606

NOTES